



- Direct connection up to 500V line voltage, up to 25kV with HV adapter
- Monitoring during both live and standby conditions
- For use in land, marine, offshore, sub-sea and ocean floor Installations
- Comply with AODC 035 Code of Practice
- "Megger" - safe to 1.4kVDC when aux power is OFF
- Immune to earth capacitance and voltage surges
- Analogue output proportional to meter reading (F-version)

Specifications

General

Auxiliary Supply:	100-120, 200-240, 380-415 or 440-460VAC, 40-70Hz (Fuse 0.5A)
Optional Voltage:	12-48VDC (>9 - <60VDC) (Fuse 2A)
Contact rating:	AC: 100VA - 250V/2A max. DC: 50W - 100V/1A max.
Analogue Output:	Up to 20mA, max 500R
F-versions	Up to 10V, min 100kohm (other on request)
Temperature:	-20 to +70°C
Weight:	0.62kgs
Front protection:	IP54 (IP65 optional)

Application

The digitally controlled KPM16x series monitors insulation level between a non-grounded (IT) AC mains and its protective earth, regardless of whether the mains is live or non-live (standby). The unit is for land, marine, offshore, sub-sea and ocean floor use.

An AC or DC auxiliary voltage is required for the unit, if powered from a separate source the network can also be monitored during standby conditions. Only **ONE** KPM16x can be connected to each IT-system. The ohmmeter and the triple-zone status LEDs give at a glance the clear safety message:

- ALARM (red zone)
- WARNING (yellow zone)
- HEALTHY (green zone)

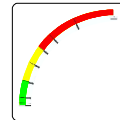

INTELLIGENT SETTING ASSISTANCE

KPM16x has a built-in Assistance tool for setting/verification of the trip levels and the analogue output.

When either the **Warning** or **Alarm** potmeter on the rear is operated by user, the meter goes into **Assistance Mode** and meter reading and analogue output will reflect the potmeter setting.

How to set alarm levels:

Firstly adjust potmeter fully clockwise (see that meter goes to the top), then adjust potmeter down to required **Warning** or **Alarm** setpoint. Without any movement of potmeters, the meter will revert to normal Insulation Monitoring Mode after approximately 10 seconds.



How to test analogue output signal:

Adjust any trip level potmeter to activate Assistance Mode. **Example:** On a 4-20mA output, adjust potmeter fully anti clockwise for 4mA and fully clockwise for 20mA.

The KPM16x range is designed to comply with specification AODC035 "Code of Practice for the Safe Use of Electricity Under Water" issued by IMCA.

The unit meets IEC60092-504 and the relevant environmental and EMC tests specified in IEC60068/60092 and IEC61000/60533 respectively, to comply with the requirements of the major Classification Societies.

General

IDV MEASURING PRINCIPLE

Insulation is measured between the complete galvanically interconnected AC network and its protective earth.

The unit injects a DC voltage signal into the monitored system. The signal flows to ground via the path of the insulation fault, the level of flow indicates the insulation resistance. The measuring accuracy is not influenced by any normal kind of load attached to the AC network.

Trip levels and delays are settable on unit rear. A trip LED flashes when the trip level is passed, the relay trips when the delay has elapsed. The timer resets if the fault is removed during countdown.

MEGGER SAFE

When auxiliary power is **OFF** the unit input is automatically protected against "megger" test voltages up to 1.4kVDC, and incorrect measurements caused by the unit's input impedance are avoided.

OUTPUTS

All F versions have an isolated **analogue output** proportional to meter reading. If output is used for remote meter reading, we recommend 0-1mA for the slave indicator.

SAFETY

When a voltage adapter (CHx, ANx or ARx) is used the signal to terminals 4 and 6 on KPM163x and KPM165x is limited to a safe level, avoiding any dangerous voltage exposure to personnel.

NOTE

Special versions of the KPM161 and KPM163 are available as:

KPM161M & KPM163M - Insulation guard with DC detection function, protected against **high-energy** DC voltage imposed on the monitored AC supply.

KPM261x & KPM263x - Insulation guard with measuring loop continuity monitoring.

Description

KPM161E2 & KPM161F - KPM161G & KPM161GF

This unit is used for hospital, industrial, marine and offshore installations. Start of monitoring function is delayed when auxiliary power is switched on (default 5 secs delay). The unit has minimum 150 mS detection time for any insulation fault.

Direct connection up to 500V line voltage.

KPM161E2-SKK - KPM161F-SKK & KPM161G-SKK & KPM161GF-SKK

These optional units are similar to KPM161E2 & KPM161F - KPM161G & KPM161GF. The only difference is, start of monitoring function is delayed when auxiliary power is switched on (1 secs delay).

Output diagram

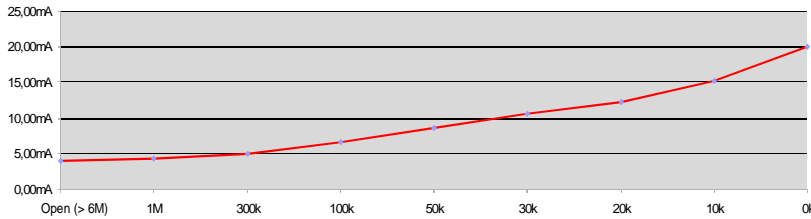

Relay Operation

Scale range: 0-1000kΩ - ∞ (>6MΩ)

	Warning	Alarm	Fail Safe	Latch
R1	✓			
R2		✓	✓	* / ✓
R3		✓	✓	* / ✓

Model	Latch	Output	Adjustments	Trip level	Delay
KPM161E2	-	-	WARNING:	0-1MΩ	0-30secs
KPM161F	-	X	ALARM:	0-1MΩ	0,1-3secs
KPM161G*	X	-			
KPM161GF*	X	X			

Coloured sectors show recommended areas of settings:
■ - Indicates alarm trip zone
■ - Indicates warning trip zone
■ - Indicates healthy zone

Output table (example for 4-20mA)

Value (scale)	mA output
0kΩ	20.00mA
10kΩ	15.22mA
20kΩ	12.32mA
30kΩ	10.61mA
50kΩ	8.68mA
100kΩ	6.69mA
300kΩ	4.98mA
1MΩ	4.28mA
Open (>6MΩ)	4.00mA

Range

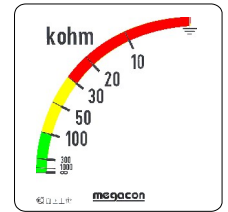

Description

KPM163E & KPM163F - KPM163G & KPM163GF

This unit is used for marine, ROV and offshore installations. Start of monitoring function is delayed when auxiliary power is switched on (default 10 secs delay). The unit has minimum 150 mS detection time for any insulation fault. (Recommended for thruster standby monitoring)

KPM163H & KPM163HF - KPM163HG & KPM163HGF

This unit is specifically designed for **sub-sea monitoring** and includes the advanced **Load Distortion and Earth-capacitance Detector (LDED)**.

The LDED function differentiates between a true (resistive) or a false (capacitive) drop in insulation reading, and will maintain reliable and accurate insulation monitoring even if load switching or a major change in load spread capacitance cause meter indication to drop **below** set relay trip levels. This situation may occur due to the latent high RC product at the high end part of the measuring range. The LDED will then momentarily inhibit all monitoring functions, freeze operation of meter, lamp display, alarm relays and analogue output for duration of a monitoring irregularity.

The unit will restore normal operation at the moment meter deflection rises **above** set alarm trip levels. **The LDED function has minimum 1 secs detection time for any insulation fault.**

Direct connection up to 500V line voltage. Up to 6,6kV via HV adaptor CH163x or AN6,6 series.

Output diagram

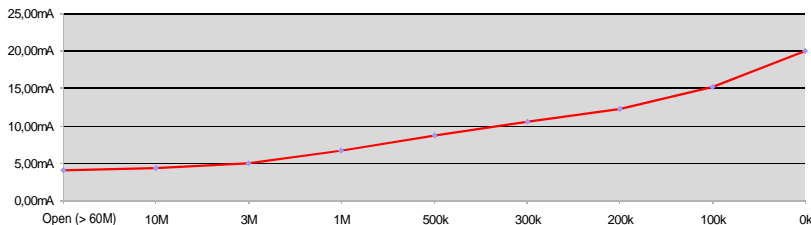

Relay Operation

Scale range: 0-10MΩ - ∞ (>60MΩ)

	Warning	Alarm	Fail Safe	Latch
R1	✓			
R2		✓	✓	* / ✓
R3		✓	✓	* / ✓

Model	Latch	Output	Adjustments	Trip level	Delay
KPM163E	-	-	WARNING:	0-10MΩ	0-30secs
KPM163F	-	X	ALARM:	0-10MΩ	0,1-3secs
KPM163G*	X	-			
KPM163GF*	X	X			
KPM163H	-	-			
KPM163HF	-	X			
KPM163HG*	X	-			
KPM163HGF*	X	X			

Coloured sectors show recommended areas of settings:
■ - Indicates alarm trip zone
■ - Indicates warning trip zone
■ - Indicates healthy zone

Output table (example for 4-20mA)

Value (scale)	mA output
0kΩ	20.00mA
100kΩ	15.18mA
200kΩ	12.30mA
300kΩ	10.59mA
500kΩ	8.67mA
1MΩ	6.69mA
3MΩ	4.98mA
10MΩ	4.28mA
Open (60MΩ)	4.00mA

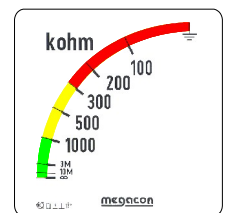

The MEGACON policy is one of continuous improvement, consequently equipment supplied may vary in detail from this publication.



Description

KPM165H & KPM165HF - KPM165HG & KPM165HGF

Start of monitoring has a 30 secs delay. This unit is for marine, offshore, sub-sea and ocean floor use. It has a wide measuring range in order to detect degradation of insulation at its origin. An important feature is the unit's unique inhibit function, controlled by the **Load Distortion and Earth-capacitance Detector (LDED)**.

The **LDED** function differentiates between a true (resistive) or a false (capacitive) drop in insulation reading, and will maintain reliable and accurate insulation monitoring even if load switching or a major change in load spread capacitance cause meter indication to drop **below** set relay trip levels. This situation may occur due to the latent high RC product at the high end part of the measuring range. The LDED will then momentarily inhibit all monitoring functions, freeze operation of meter, lamp display, alarm relays and analogue output for duration of a monitoring irregularity.

The unit will restore normal operation at the moment meter deflection rises **above** set alarm trip levels. The **LDED** function has **minimum 5 secs detection time for any insulation fault**.

Connection up to 25kV via HV adaptor ARx or ANx series.

Output diagram

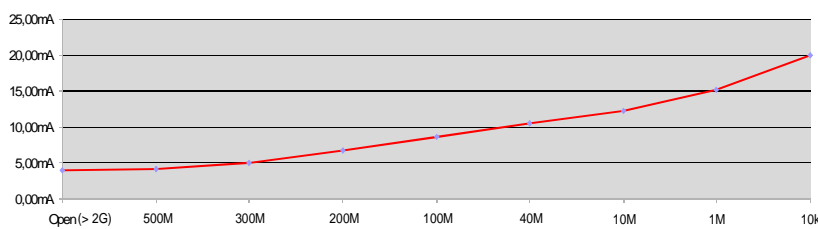

Relay Operation

Scale range: 10kΩ-500MΩ - ∞ (>2GΩ)

	Warning	Alarm	Fail Safe	Latch
R1	✓			
R2		✓	✓	* / ✓
R3		✓	✓	* / ✓

Model	Latch	Output	Adjustments	Trip level	Delay
KPM165H	-	-	WARNING:	10kΩ-400kΩ	0-30secs
KPM165HF	-	X	ALARM:	10kΩ-400kΩ	0-30secs
KPM165HG*	X	-			
KPM165HGF*	X	X			

Coloured sectors show recommended areas of settings:
■ - Indicates alarm trip zone
■ - Indicates warning trip zone
■ - Indicates healthy zone

Output table (example for 4-20mA)

Value (scale)	mA output
10kΩ	20.00mA
1MΩ	14.84mA
10MΩ	12.28mA
40MΩ	10.57mA
100MΩ	8.63mA
200MΩ	6.64mA
300MΩ	4.93mA
500MΩ	4.20mA
Open (>2GΩ)	4.00mA

Range

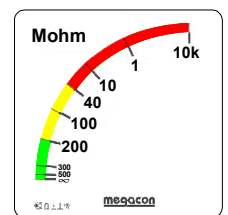

Description

KPM165G1 & KPM165GF1 - KPM165L1 & KPM165LF1

Start of monitoring has a 30 secs delay. This unit is for marine, offshore, sub-sea and ocean floor use. It has a wide measuring range in order to detect degradation of insulation at its origin. An important feature is the unit's unique inhibit function, controlled by the **Load Distortion and Earth-capacitance Detector (LDED)**.

The **LDED** function differentiates between a true (resistive) or a false (capacitive) drop in insulation reading, and will maintain reliable and accurate insulation monitoring even if load switching or a major change in load spread capacitance cause meter indication to drop **below** set relay trip levels. This situation may occur due to the latent high RC product at the high end part of the measuring range. The LDED will then momentarily inhibit all monitoring functions, freeze operation of meter, lamp display, alarm relays and analogue output for duration of a monitoring irregularity.

The unit will restore normal operation at the moment meter deflection rises **above** set alarm trip levels. The **LDED** function has **minimum 5 secs detection time for any insulation fault**.

Connection up to 25kV via HV adaptor ARx or ANx series.

Output diagram

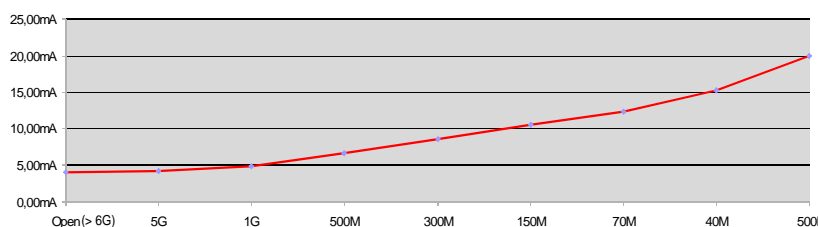

Relay Operation

Scale range: 500kΩ-5GΩ - ∞ (>6GΩ)

	Warning	Alarm	Fail Safe	Latch
R1	✓			
R2		✓	✓	* / ✓
R3		✓	✓	* / ✓

Model	Latch	Output	Adjustments	Trip level	Delay
KPM165G1*	X	-	WARNING:	500kΩ-3GΩ	0-30secs
KPM165GF1*	X	X	ALARM:	500kΩ-3GΩ	0-30secs
KPM165L1	-	-			
KPM165LF1	-	X			

Coloured sectors show recommended areas of settings:
■ - Indicates alarm trip zone
■ - Indicates warning trip zone
■ - Indicates healthy zone

Output table (example for 4-20mA)

Value (scale)	mA output
500kΩ	20.00mA
40MΩ	15.18mA
70MΩ	12.28mA
150MΩ	10.57mA
300MΩ	8.63mA
500MΩ	6.64mA
1GΩ	4.93mA
5GΩ	4.20mA
Open (>6GΩ)	4.00mA

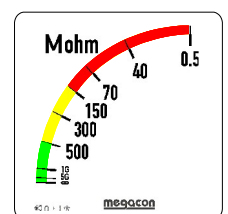

The MEGACON policy is one of continuous improvement, consequently equipment supplied may vary in detail from this publication.



Description

KPM165E1 & KPM165F1 - KPM165N1 & KPM165NF1

Start of monitoring has a 30 secs delay. This unit is for marine, offshore, sub-sea and ocean floor use. It has a wide measuring range in order to detect degradation of insulation at its origin. An important feature is the unit's unique inhibit function, controlled by the **Load Distortion and Earth-capacitance Detector (LDED)**.

The **LDED** function differentiates between a true (resistive) or a false (capacitive) drop in insulation reading, and will maintain reliable and accurate insulation monitoring even if load switching or a major change in load spread capacitance cause meter indication to drop **below** set relay trip levels. This situation may occur due to the latent high RC product at the high end part of the measuring range. The LDED will then momentarily inhibit all monitoring functions, freeze operation of meter, lamp display, alarm relays and analogue output for duration of a monitoring irregularity.

The unit will restore normal operation at the moment meter deflection rises **above** set alarm trip levels. The **LDED** function has **minimum 5 secs detection time for any insulation fault**.

Connection up to 25kV via HV adaptor ARx or ANx series.

Output diagram

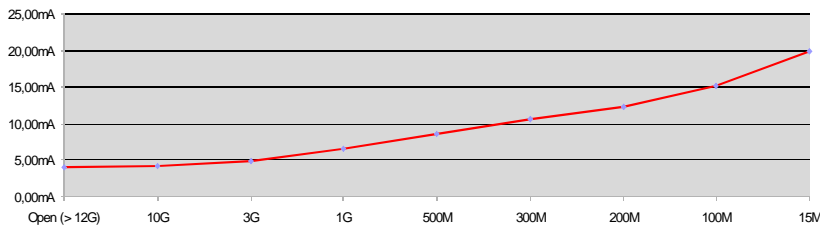

Relay Operation

Scale range: 15MΩ-10GΩ - ∞ (>12GΩ)

	Warning	Alarm	Fail Safe	Latch
R1	✓			
R2		✓	✓	* ✓
R3		✓	✓	* ✓

Model	Latch	Output	Adjustments	Trip level	Delay
KPM165E1*	X	-	WARNING:	15MΩ-5GΩ	0-30secs
KPM165F1*	X	X	ALARM:	15MΩ-5GΩ	0-30secs
KPM165N1	-	-			
KPM165NF1	-	X			

Coloured sectors show recommended areas of settings:
■ - Indicates alarm trip zone
■ - Indicates warning trip zone
■ - Indicates healthy zone

Output table (example for 4-20mA)

Value (scale)	mA output
15MΩ	20.00mA
100MΩ	15.18mA
200MΩ	12.28mA
300MΩ	10.57mA
500MΩ	8.63mA
1GΩ	6.64mA
3GΩ	4.93mA
10GΩ	4.20mA
Open (>12GΩ)	4.00mA

Range

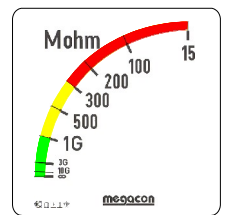

High Voltage Adaptors up to 25kVAC for KPM163x & KPM165x series



CH163/1,4 up to 1.4kVAC
(for KPM163x series)



CH163/3,6 up to 3.6kVAC
(for KPM163x series)



CH163/5 up to 5kVAC
(for KPM163x series)



AN6,6 up to 6,6kVAC
(for KPM163x series)



AN7 up to 7kVAC
(for KPM165x series)



AN14 up to 14kVAC
(for KPM165x series)



AN25 up to 25kVAC
(for KPM165x series)



AR7 up to 7kVAC
(for KPM165x series)



AR14 up to 14kVAC
(for KPM165x series)

The MEGACon policy is one of continuous improvement, consequently equipment supplied may vary in detail from this publication.



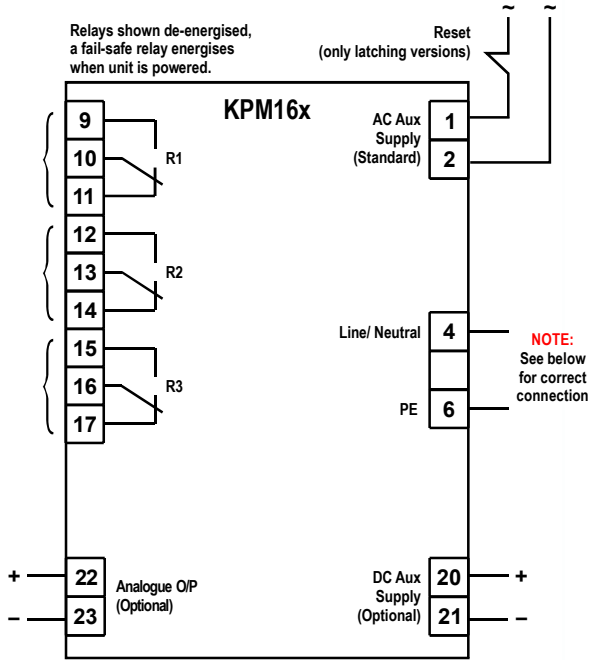

Analogue Output

KPM161F, KPM161GF, KPM163F, KPM163GF, KPM163H, KPM163HGF, KPM165HF, KPM165HGF, KPM165GF1, KPM165LF1, KPM165F1 and KPM165NF1 have an analogue output proportional to meter reading. (Special outputs are available on request)

Add suffix from table below to type designation to specify output required:

O/P1	0 - 10mA	O/P6	N/A
O/P2	0 - 20mA	O/P7	N/A
O/P3	4 - 20mA	O/P8	0 - 10VDC
O/P4	N/A	O/P9	N/A
O/P5	N/A	O/P10	N/A

Dimensions

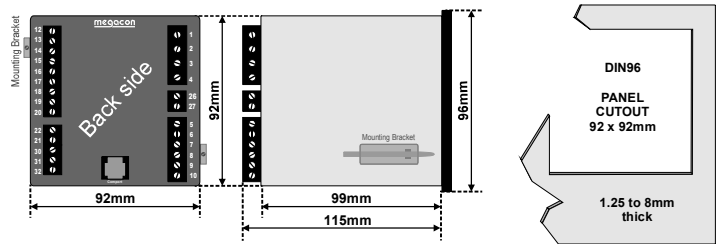

NEUTRAL VOLTAGE INPUT

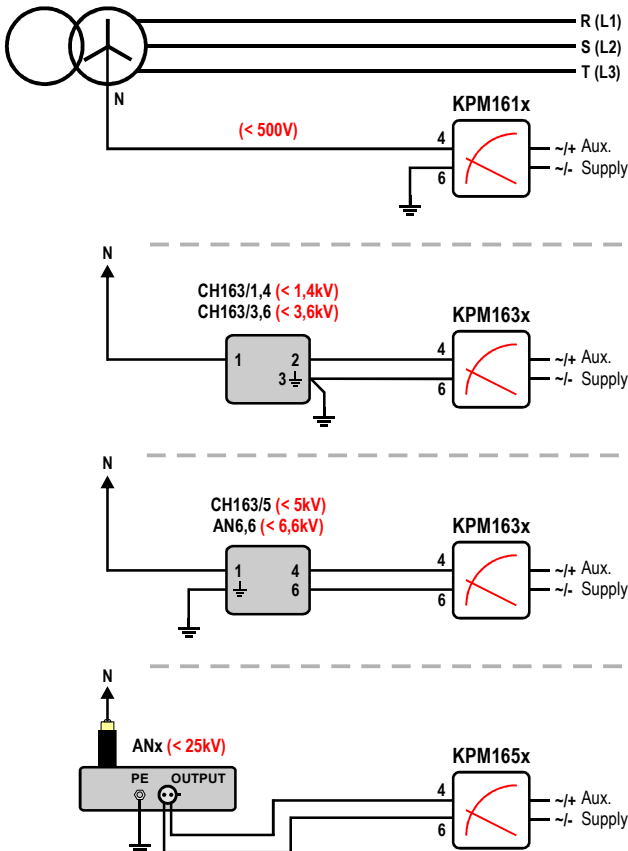

LINE VOLTAGE INPUT

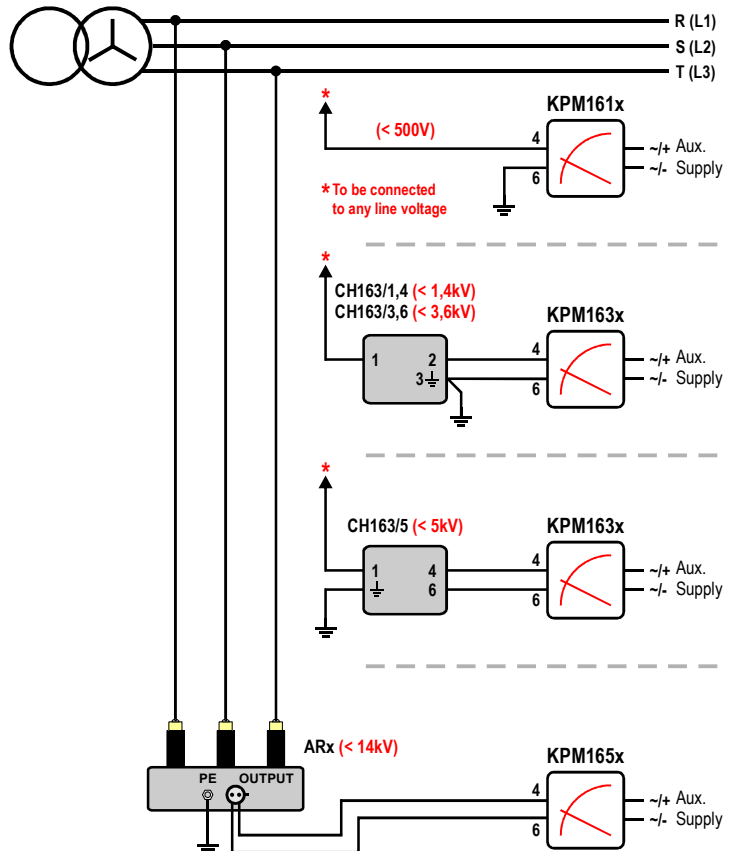

The MEGAICON policy is one of continuous improvement, consequently equipment supplied may vary in detail from this publication.

ORDERING EXAMPLE:

Type: KPM165GF1
 Aux. Supply: 200-240VAC
 Network Voltage: 14kVAC
 Analogue O/P: (O/P3) 4-20mA
 Range: 500K - 5Gohm

