



- Non-stop "megging" of AC or DC non-grounded networks, pumps, emergency generators and thrusters during inactive (disconnected, idle or standby) condition
- For maximum 690V system voltage
- Triple-zone insulation monitoring, a must for preventive maintenance
- Immune to earth spread capacitance
- For use in land, offshore and marine systems
- Analogue output proportional to meter reading (F-version)

Specifications

General

Auxiliary Supply:	100-120, 200-240, 380-415 or 440-460VAC, 40-70Hz (Fuse 0.5A)
Optional Voltage:	12-48VDC (>9 - <60VDC) (Fuse 2A)
Contact rating:	AC: 100VA - 250V/2A max. DC: 50W - 100V/1A max.
Analogue Output:	Up to 20mA, max 500R
F-versions	Up to 10V, min 100kohm (other on request)
Temperature:	-20 to +70°C
Weight:	0.62kgs
Front protection:	IP54 (IP65 optional)

INTELLIGENT SETTING ASSISTANCE

KPM465x has a built-in Assistance tool for setting/verification of the trip levels and the analogue output.

When either the **Warning** or **Alarm** potmeter at the rear is operated by user, the meter goes into **Assistance Mode** and meter reading and analogue output will reflect the potmeter setting.

How to set alarm levels:

Firstly adjust potmeter fully clockwise (see that meter goes to the top), then adjust potmeter down to required **Warning** or **Alarm** setpoint. Without any movement of potmeters, the meter will revert to normal Insulation Monitoring Mode after approximately 10 seconds.



How to test analogue output signal:

Adjust any trip level potmeter to activate Assistance Mode. **Example:** On a 4-20mA output, adjust potmeter fully anti clockwise for 4mA and fully clockwise for 20mA.

The KPM465x range is designed to comply with specification AODC035 "Code of Practice for the Safe Use of Electricity Under Water" issued by IMCA.

The unit meets IEC60092-504 and the relevant environmental and EMC tests specified in IEC60068/60092 and IEC61000/60533 respectively, to comply with the requirements of the major Classification Societies.

Application

The digitally controlled KPM465x monitors insulation level between a non-live non-grounded (IT) system and its protective earth. This unit is used for land, offshore and marine installations for megging of any inactive equipment.

When running, the centrifugal force and heat of windings will keep a machine dry. When machines is not running ambient humidity may condensate and form moisture traps, which, together with accumulated dust and contaminated deposits, may form leakage paths to earth.

Idling operation interrupts general insulation monitoring and leaves machine insulation to degrade uncontrolled during a lasting outage.

KPM465E can be connected to any kind of non-live electrical system, to monitor the general health during inactive operation. KPM465E will also detect any earth fault caused by break-down and flash-over carbon deposits or mechanical damage to windings and cabling.

An AC or DC auxiliary voltage is required for the unit. Only **ONE** KPM465E can be connected to each IT-system. The ohmmeter and the triple-zone status LEDs give at a glance the clear safety message:

- ALARM (red zone)
- WARNING (yellow zone)
- HEALTHY (green zone)

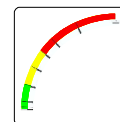

General

IDV MEASURING PRINCIPLE

Insulation is measured between the complete galvanically interconnected AC network and its protective earth. The unit injects a DC measuring signal into the monitored system. The signal flows to ground via the path of the insulation fault, the level of flow indicates the insulation resistance. The measuring accuracy is not influenced by spread capacitance.

The KPM465E measures all phases just by connection to either line or neutral point. Start of monitoring function is delayed when auxiliary power is switched on (default 10 secs delay) to avoid false reading caused by initial charging of network spread capacitance. If powered from separate source there can be a stabilizing time if there is network spread capacitance.

OUTPUTS

The unit has C/O relay outputs for Warning and Alarm. The Alarm relays are fail to safety configured. A trip LED flashes when the trip level is passed, the relay trips when the delay has elapsed. The timer resets if the fault is removed during countdown. Trip levels and delays are settable on unit rear.

The F-version is supplied with an analogue output proportional to meter reading for remote reading/logging of insulation condition.

KPM465H & KPM465HF - KPM465HG & KPM465HGF

Scale range: 10kΩ-500MΩ - ∞ (>2GΩ)

Output diagram

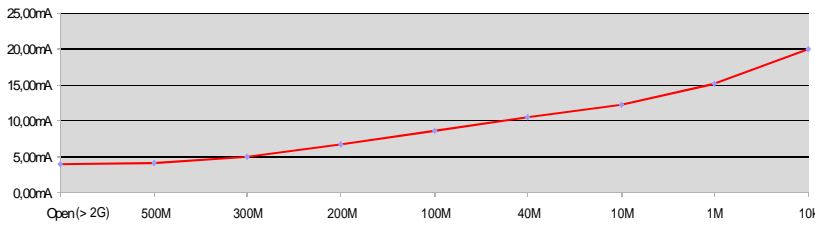

Model	Latch	Output	Warning	Alarm	Fail Safe	Latch
KPM465H	-	-	✓			
KPM465HF	-	X		✓	✓	*✓
KPM465HG*	X	-		✓	✓	*✓
KPM465HGF*	X	X		✓	✓	*✓

Output table (example for 4-20mA) Range

Value (scale)	mA output
10kΩ	20.00mA
1MΩ	14.84mA
10MΩ	12.28mA
40MΩ	10.57mA
100MΩ	8.63mA
200MΩ	6.64mA
300MΩ	4.93mA
500MΩ	4.20mA
Open (>2GΩ)	4.00mA

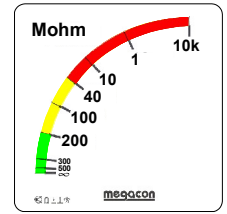

Adjustments
 WARNING: Trip level 10kΩ-400kΩ Delay 0-30secs
 ALARM: Trip level 10kΩ-400kΩ Delay 0-30secs

Coloured sectors show recommended areas of settings:
 - Indicates alarm trip zone
 - Indicates warning trip zone
 - Indicates healthy zone

KPM465G & KPM465GF - KPM465L & KPM465LF

Scale range: 500kΩ-5GΩ - ∞ (>6GΩ)

Output diagram

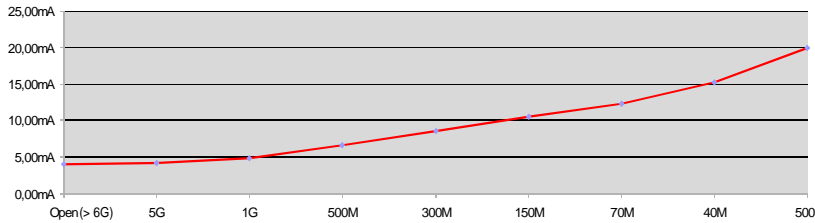

Model	Latch	Output	Warning	Alarm	Fail Safe	Latch
KPM465G*	X	-	✓			
KPM465GF*	X	X		✓	✓	*✓
KPM465L	-	-		✓	✓	*✓
KPM465LF	-	X		✓	✓	*✓

Output table (example for 4-20mA) Range

Value (scale)	mA output
500kΩ	20.00mA
40MΩ	15.18mA
70MΩ	12.28mA
150MΩ	10.57mA
300MΩ	8.63mA
500MΩ	6.64mA
1GΩ	4.93mA
5GΩ	4.20mA
Open (>6GΩ)	4.00mA

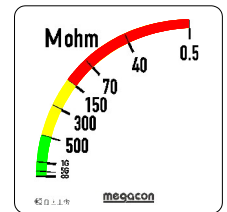

Adjustments
 WARNING: Trip level 500kΩ-3GΩ Delay 0-30secs
 ALARM: Trip level 500kΩ-3GΩ Delay 0-30secs

Coloured sectors show recommended areas of settings:
 - Indicates alarm trip zone
 - Indicates warning trip zone
 - Indicates healthy zone

KPM465E & KPM465F - KPM465N & KPM465NF

Scale range: 15MΩ-10GΩ - ∞ (>12GΩ)

Output diagram

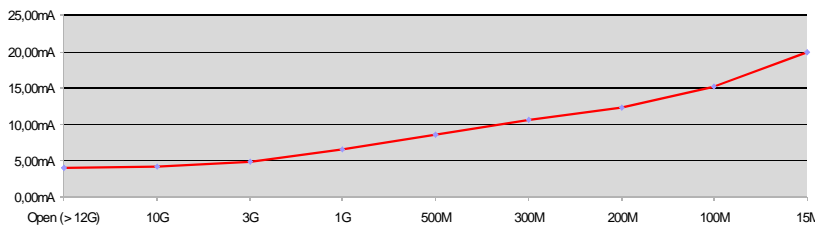

Model	Latch	Output	Warning	Alarm	Fail Safe	Latch
KPM465E*	X	-	✓			
KPM465F*	X	X		✓	✓	*✓
KPM465N	-	-		✓	✓	*✓
KPM465NF	-	X		✓	✓	*✓

Output table (example for 4-20mA) Range

Value (scale)	mA output
15MΩ	20.00mA
100MΩ	15.18mA
200MΩ	12.28mA
300MΩ	10.57mA
500MΩ	8.63mA
1GΩ	6.64mA
3GΩ	4.93mA
10GΩ	4.20mA
Open (>12GΩ)	4.00mA

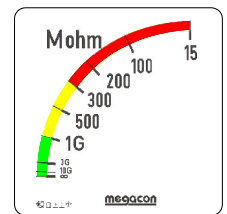

Adjustments
 WARNING: Trip level 15MΩ-5GΩ Delay 0-30secs
 ALARM: Trip level 15MΩ-5GΩ Delay 0-30secs

Coloured sectors show recommended areas of settings:
 - Indicates alarm trip zone
 - Indicates warning trip zone
 - Indicates healthy zone

The MEGACON policy is one of continuous improvement, consequently equipment supplied may vary in detail from this publication.



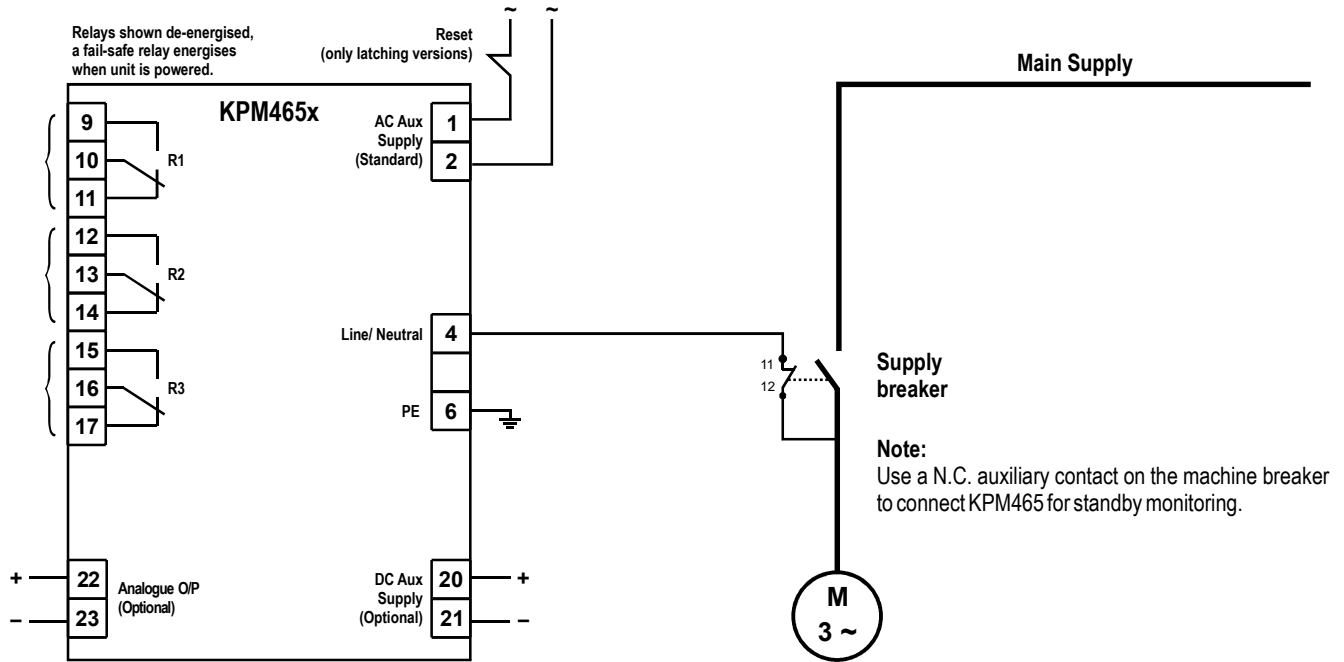

SAFETY

The unit is megger safe but megger will measure the internal resistance of approximately 1,7Mohm if unit is connected. The unit is not for live measuring but will not be damaged if network voltage is accidentally connected.

Analogue Output

KPM465HF, KPM465HGF, KPM465GF, KPM465LF, KPM465F and KPM465NF have an analogue output proportional to meter reading. (Special outputs are available on request)

Add suffix from table below to type designation to specify output required:

O/P1	0 - 10mA	O/P6	N/A
O/P2	0 - 20mA	O/P7	N/A
O/P3	4 - 20mA	O/P8	0 - 10VDC
O/P4	N/A	O/P9	N/A
O/P5	N/A	O/P10	N/A

Dimensions

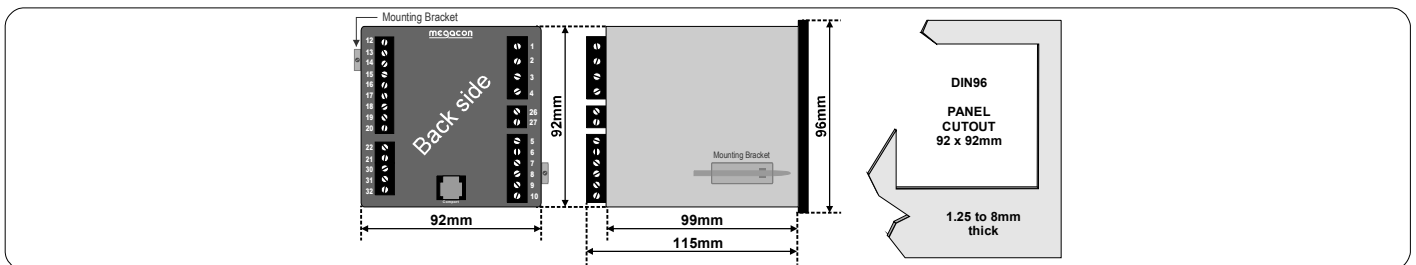

The MEGAcon policy is one of continuous improvement, consequently equipment supplied may vary in detail from this publication.

ORDERING EXAMPLE:

Type: KPM465F
 Aux. Supply: 200-240VAC
 Analogue O/P: (O/P3) 4-20mA

